

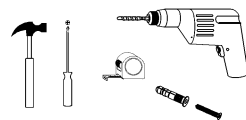

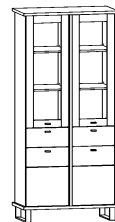









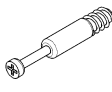



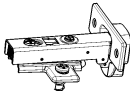



# CRO-26 Witryna 2D2S

L-90 H-195 D-45

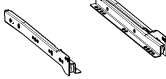
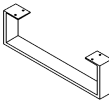

90 min

<b>x 20</b>  AKC00019	<b>x 8</b>  7x50 AKC00120	<b>x 6</b>  7x70 AKC00056	<b>x 14</b>  AKC00004	<b>x 14</b>  AKC00029	<b>x 12</b>  AKC00151
<b>x 2</b>  AKC00152	<b>x 14</b>  AKC00004	<b>x 8</b>  ZAW00025	<b>x 4</b>  AKC00036	<b>x 24</b>  AKC00023	<b>x 2</b>  AKC00153
<b>x 90</b>  AKC00018	<b>x 45</b>  3,5x16 AKC00026	<b>x 12</b>  4x20 AKC00026	<b>x 20</b>  3,5x30 AKC00026	<b>x 12</b>  4x25 AKC00026	<b>x 1</b>  AKC00040
<b>x 2</b>  HDF	<b>x 6</b>  UCH00056	<b>x 1</b>  AKC00017	<b>x 2</b> L-400 mm  MEC00396	<b>x 2</b>  NOG00044	

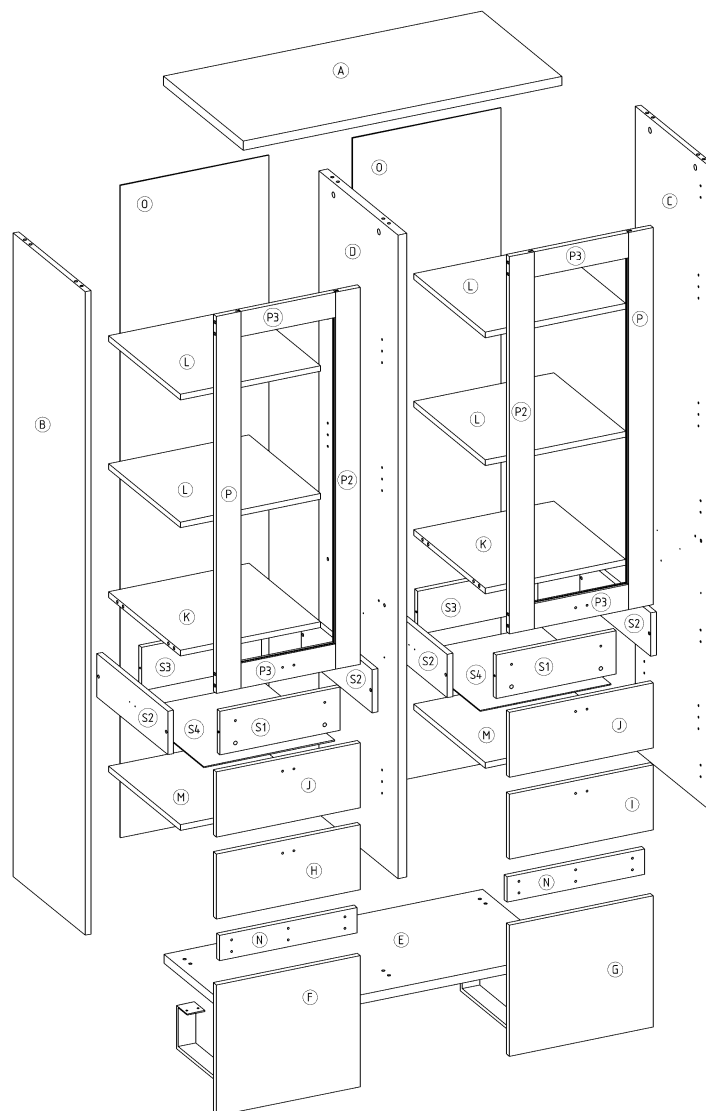

1

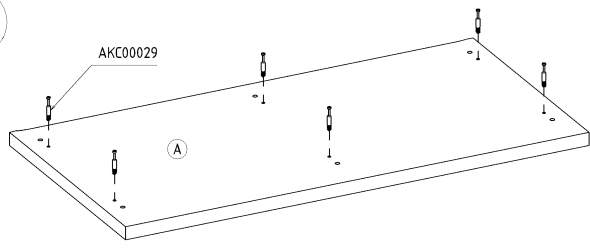

x 2

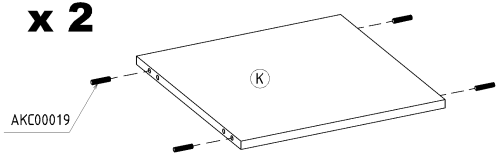

2

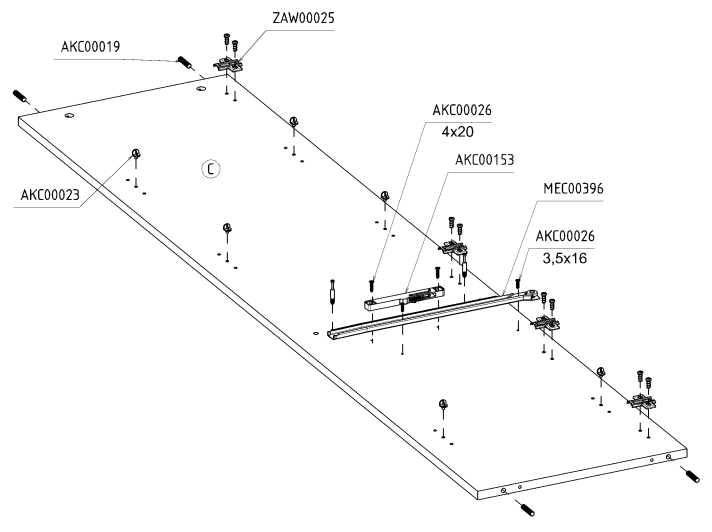
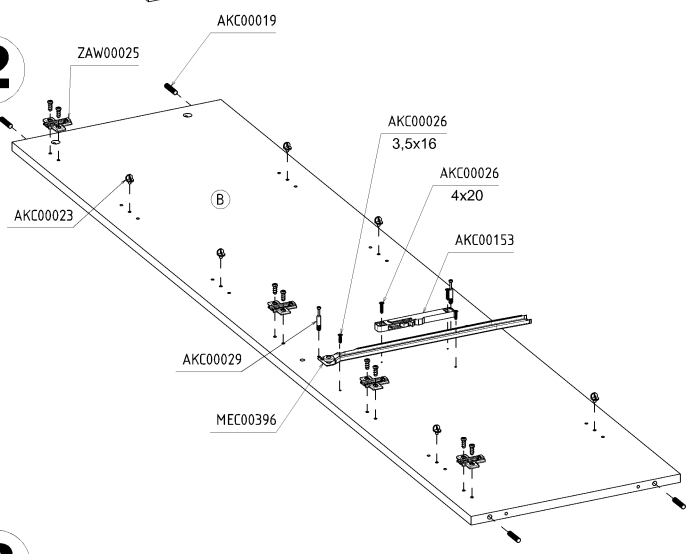

3

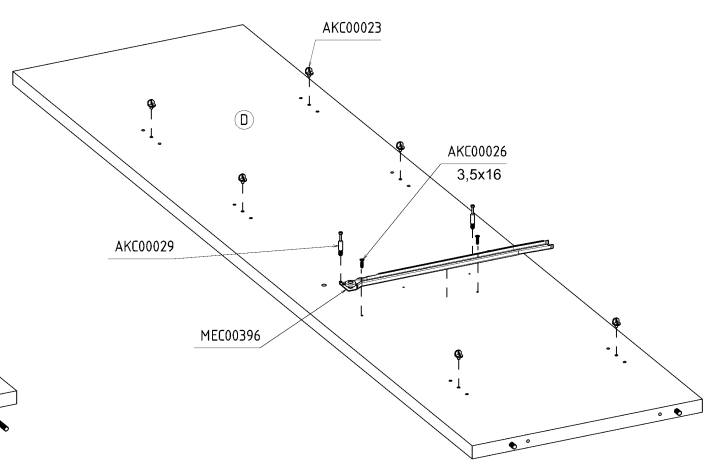
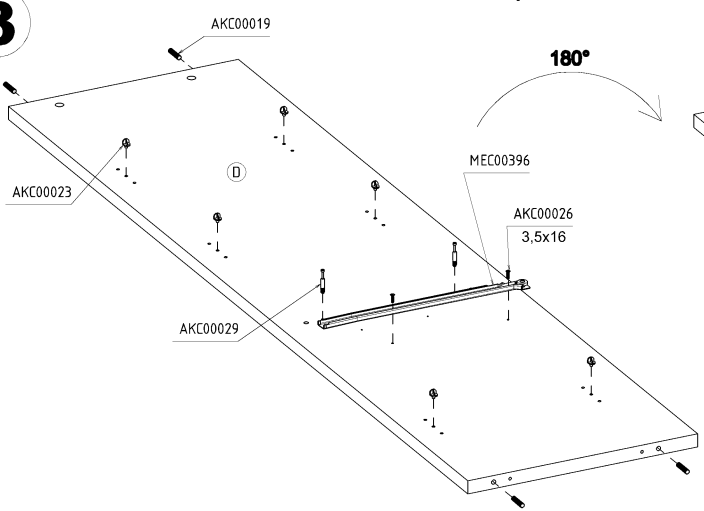

4

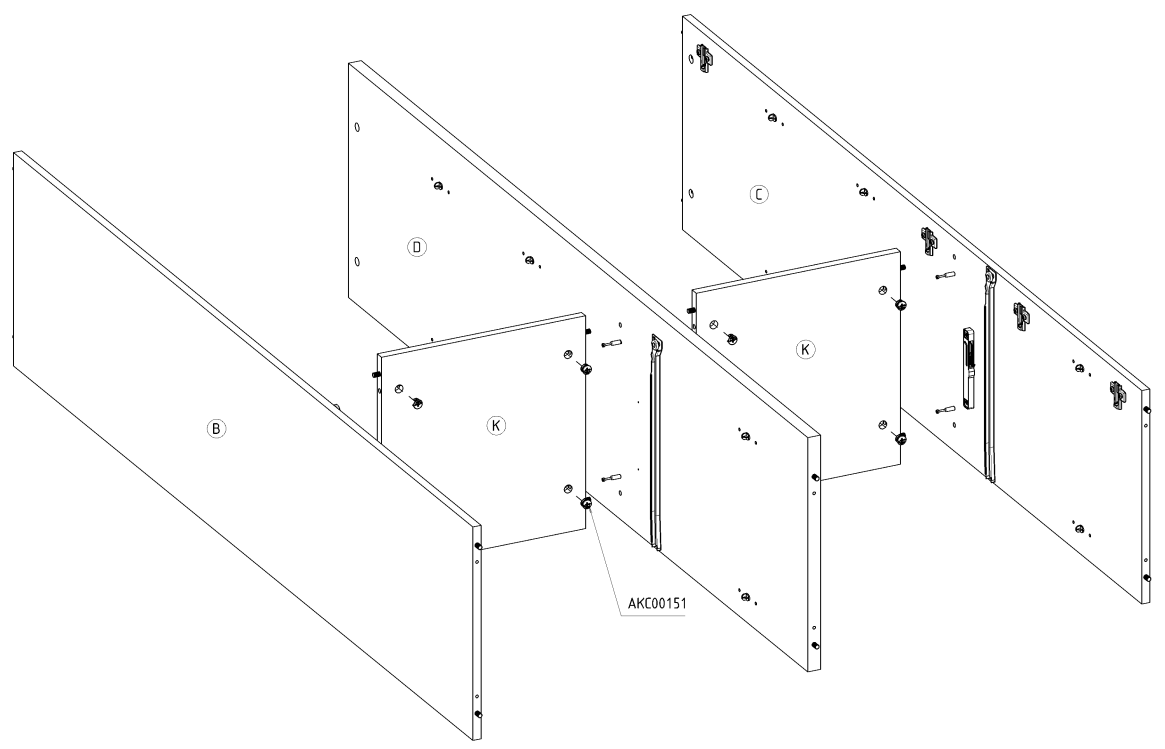

5

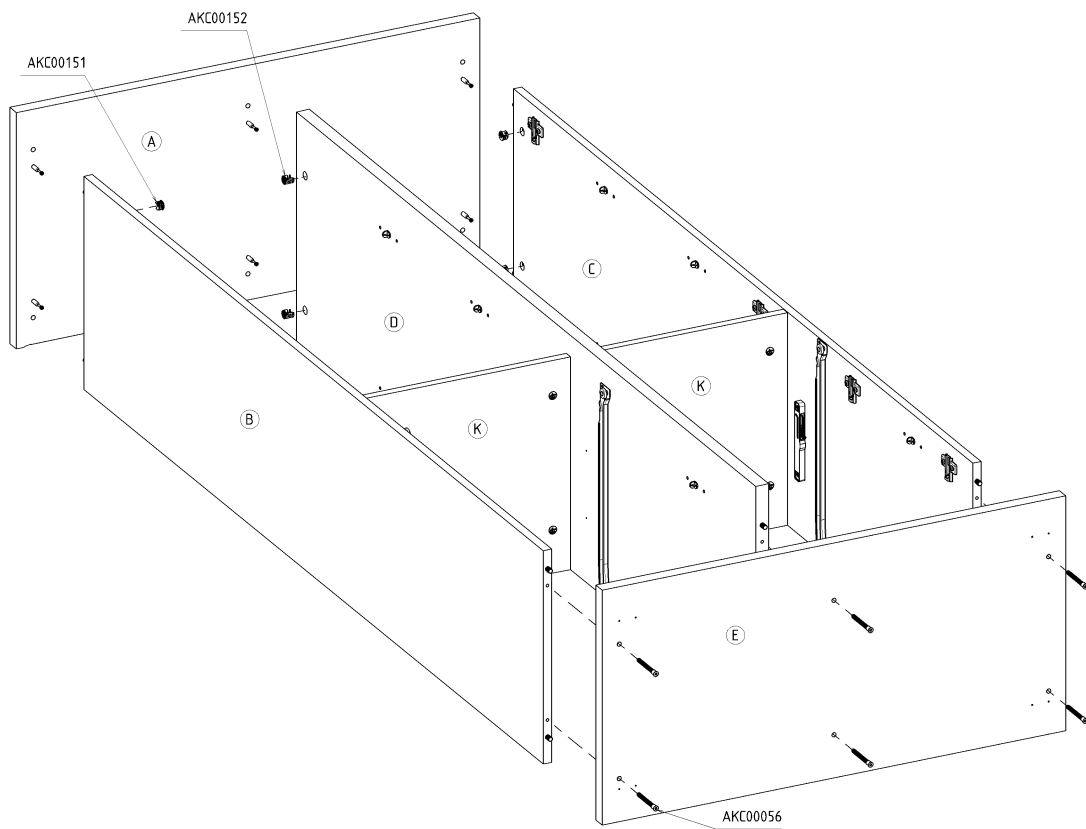

6

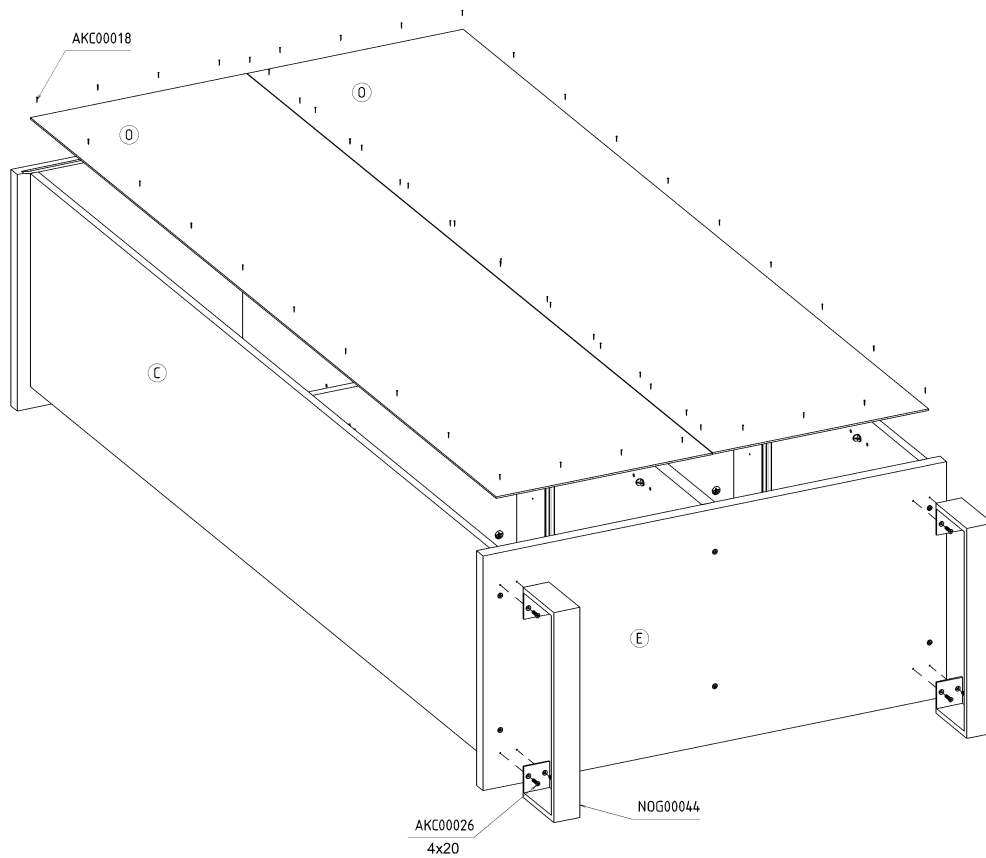

7

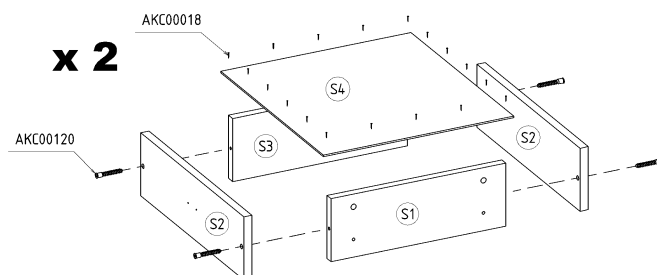

8

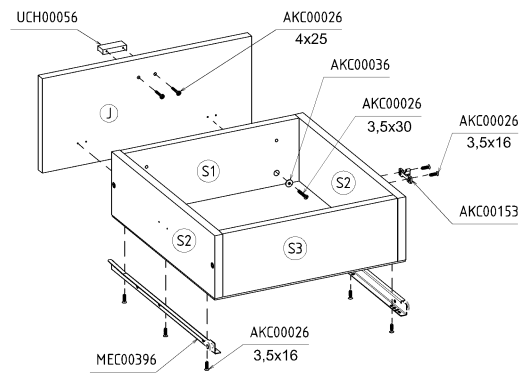
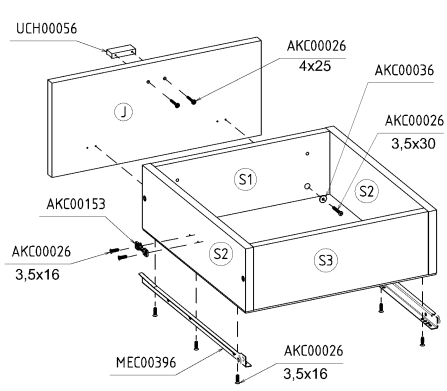

9

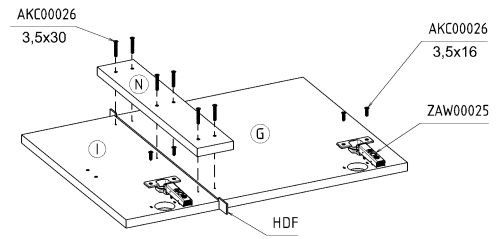
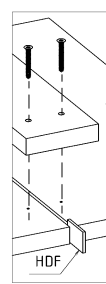
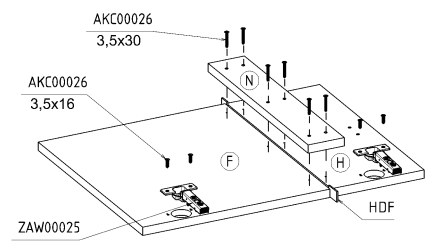

10

